

# Inland Waters & Catchment Ecology

SOUTH AUSTRALIAN RESEARCH & DEVELOPMENT INSTITUTE  
**PIRSA**

Establishment success and benefits to the aquatic plant community of planting *Schoenoplectus validus* around the shorelines of lakes Alexandrina and Albert  
Data and methods report



Jason Nicol, Susan Gehrig and Kate Frahn

SARDI Publication No. F2013/000414-1  
SARDI Research Report Series No. 711

SARDI Aquatic Sciences  
PO Box 120 Henley Beach SA 5022

August 2013

**PREMIUM**  
FOOD AND WINE FROM OUR  
**CLEAN**  
ENVIRONMENT



**Establishment success and benefits to the aquatic plant  
community of planting *Schoenoplectus validus* around the  
shorelines of lakes Alexandrina and Albert  
Data and methods report**

**Jason Nicol, Susan Gehrig and Kate Frahn**

**SARDI Publication No. F2013/000414-1  
SARDI Research Report Series No. 711**

**August 2013**

This Publication may be cited as:

Nicol, J.M., Gehrig, S.L. and Frahn, K.A. (2013). Establishment success and benefits to the aquatic plant community of planting *Schoenoplectus validus* around the shorelines of lakes Alexandrina and Albert Data and methods report. South Australian Research and Development Institute (Aquatic Sciences), Adelaide. SARDI Publication No. F2013/000414-1. SARDI Research Report Series No. 711. 27pp.

Cover Photo: Shoreline of Lake Alexandrina at Raukkan showing *Ceratophyllum demersum*, *Phragmites australis* and *Schoenoplectus validus* (Regina Durbridge).

### **South Australian Research and Development Institute**

SARDI Aquatic Sciences  
2 Hamra Avenue  
West Beach SA 5024

Telephone: (08) 8207 2400

Facsimile: (08) 8207 5406

<http://www.sardi.sa.gov.au>

### **DISCLAIMER**

The authors warrant that they have taken all reasonable care in producing this report. The report has been through the SARDI internal review process, and has been formally approved for release by the Research Chief, Aquatic Sciences. Although all reasonable efforts have been made to ensure quality, SARDI does not warrant that the information in this report is free from errors or omissions. SARDI does not accept any liability for the contents of this report or for any consequences arising from its use or any reliance placed upon it. The SARDI Report Series is an Administrative Report Series which has not been reviewed outside the department and is not considered peer-reviewed literature. Material presented in these Administrative Reports may later be published in formal peer-reviewed scientific literature.

### **© 2013 SARDI**

This work is copyright. Apart from any use as permitted under the *Copyright Act* 1968 (Cth), no part may be reproduced by any process, electronic or otherwise, without the specific written permission of the copyright owner. Neither may information be stored electronically in any form whatsoever without such permission.

Printed in Adelaide: August 2013

SARDI Publication No. F2013/000414-1

SARDI Research Report Series No. 711

Authors: Jason Nicol, Susan Gehrig and Kate Frahn

Reviewers: Rod Ward and Chris Bice

Approved by: Dr Qifeng Ye  
Science Leader – Inland Waters & Catchment Ecology

Signed:



Date: 28 August 2013

Distribution: DEWNR, SEWPAC, SAASC Library, University of Adelaide Library, Parliamentary Library, State Library and National Library

Circulation: Public Domain

## Table of Contents

Table of Contents.....	i
List of Figures .....	ii
List of Tables.....	iii
List of Appendices .....	iii
Acknowledgements .....	1
Executive Summary.....	2
1. Introduction and context.....	4
2. Methods .....	5
2.1. Vegetation surveying protocol.....	5
Survivorship, density, height and extent of <i>Schoenoplectus validus</i> plantings.....	6
Benefit of <i>Schoenoplectus validus</i> plantings for the aquatic plant community.....	7
2.2. Data analysis .....	8
2.3. Plant identification and nomenclature.....	9
3. Results .....	9
3.1. Survivorship, density, height and extent of <i>Schoenoplectus validus</i> plantings .....	9
Survivorship .....	9
Stem density .....	10
Maximum stem height.....	11
Mean stem height .....	12
Stand width .....	13
3.2. Benefit of <i>Schoenoplectus validus</i> plantings for the aquatic plant community .....	14
Dumandang.....	14
Lake Albert Road .....	15
Meningie Foreshore.....	16
Nurra Nurra Point .....	17
Raukkan .....	18
Wellington Lodge.....	19
4. Discussion .....	20
4.1. Future research and monitoring.....	22
5. References .....	22
6. Appendices .....	25

## List of Figures

<b>Figure 1:</b> Aerial photograph of lakes Alexandrina and Albert showing the survey locations.....	6
<b>Figure 2:</b> Plan view of a planted shoreline section showing the stand width measurement and quadrats within which stem density and height measurements were undertaken.....	7
<b>Figure 3:</b> Plan view of planted and control shoreline sections showing the placement of vegetation monitoring transects.....	7
<b>Figure 4:</b> Vegetation surveying protocol for each transect: plan view showing placement of quadrats relative to the shoreline and transect.....	8
<b>Figure 5:</b> <i>Schoenoplectus validus</i> stem density (stems m <sup>-2</sup> ) for each planted site in lakes Alexandrina and Albert, May 2013 (error bars=±1 SE).....	10
<b>Figure 6:</b> Relationship between <i>Schoenoplectus validus</i> stem density (stems m <sup>-2</sup> ) and stand age, for each planted site in lakes Alexandrina and Albert, May 2013 (error bars=±1 SE). ....	10
<b>Figure 7:</b> <i>Schoenoplectus validus</i> maximum stem height for each planted site in lakes Alexandrina and Albert, May 2013 (error bars=±1 SE).....	11
<b>Figure 8:</b> Relationship between <i>Schoenoplectus validus</i> maximum stem height and stand age, for each planted site in lakes Alexandrina and Albert, May 2013 (error bars=±1 SE). ....	11
<b>Figure 9:</b> <i>Schoenoplectus validus</i> mean stem height for each planted site in lakes Alexandrina and Albert, May 2013 (error bars=±1 SE).....	12
<b>Figure 10:</b> Relationship between <i>Schoenoplectus validus</i> mean stem height and stand age, for each planted site in lakes Alexandrina and Albert, May 2013 (error bars=±1 SE).....	12
<b>Figure 11:</b> <i>Schoenoplectus validus</i> stand width for each planted site in lakes Alexandrina and Albert, May 2013 (error bars=±1 SE).....	13
<b>Figure 12:</b> Relationship between <i>Schoenoplectus validus</i> stand width and stand age, for each planted site in lakes Alexandrina and Albert, May 2013 (error bars=±1 SE).....	13
<b>Figure 13:</b> MDS ordination comparing plant community at +0.8, +0.6, +0.4, +0.2 and 0 m AHD between planted and control shoreline at Dumandang, May 2013. Stress = 0.02.....	14
<b>Figure 14:</b> MDS ordination comparing plant community at +0.8, +0.6, +0.4, +0.2 and 0 m AHD between planted and control shoreline at Lake Albert Road, May 2013. Stress = 0.01. ....	15
<b>Figure 15:</b> MDS ordination comparing plant community at +0.8, +0.6, +0.4, +0.2 and 0 m AHD between planted and control shoreline at Meningie Foreshore, May 2013. Stress =0.04. ....	16
<b>Figure 16:</b> MDS ordination comparing plant community at +0.8, +0.6, +0.4, +0.2 and 0 m AHD between planted (new and old plantings) and control shoreline at Nurra Nurra Point, May 2013. Stress =0.09. ....	17
<b>Figure 17:</b> MDS ordination comparing plant community at +0.8, +0.6, +0.4, +0.2 and 0 m AHD between planted and control shoreline at Raukkan, May 2013. Stress =0.02. ....	18

**Figure 18:** MDS ordination comparing plant community at +0.8, +0.6, +0.4, +0.2 and 0 m AHD between planted and control shoreline at Wellington Lodge, May 2013. Stress =0.06.....19

## List of Tables

<b>Table 1:</b> Modified Braun-Blanquet (1932) scale estimating cover/abundance as per Heard and Channon (1997). .....	8
<b>Table 2:</b> PERAMNOVA results comparing the shoreline plant community between +0.8 and 0m AHD between the planted and control sites at Dumandang. ....	14
<b>Table 3:</b> PERAMNOVA results comparing the shoreline plant community between +0.8 and 0m AHD between the planted and control shoreline at Lake Albert Road. ....	15
<b>Table 4:</b> PERAMNOVA results comparing the shoreline plant community between +0.8 and 0m AHD between the planted and control shoreline at Meningie Foreshore. ....	16
<b>Table 5:</b> PERAMNOVA results comparing the shoreline plant community between +0.8 and 0m AHD between the planted and control shoreline at Nurra Nurra Point. ....	17
<b>Table 6:</b> PERAMNOVA results comparing the shoreline plant community between +0.8 and 0m AHD between the planted and control shoreline at Raukkan. ....	18
<b>Table 7:</b> PERAMNOVA results comparing the shoreline plant community between +0.8 and 0m AHD between the planted and control shoreline at Wellington Lodge. ....	19

## List of Appendices

<b>Appendix 1:</b> GPS coordinates (UTM format; map datum WGS 84) of survey sites and when <i>Schoenoplectus validus</i> was planted at each site. ....	25
<b>Appendix 2:</b> Species list and functional group classification ( <i>sensu</i> Casanova 2011) in planted and control areas in lakes Alexandrina and Albert (*denotes exotic species, **denotes proclaimed pest plant in South Australia). ....	26

## **Acknowledgements**

The authors thank Regina Durbridge and Arthur Walker for field assistance; Derek Walker, Glenn Pitchford, Charles Andre, Joanne Andre, Keith McFairlane and Janet McFairlane for access to their properties and Rod Ward, Chris Bice, Sacha Jellinek, Regina Durbridge and Thai Te for constructive comments on early drafts of this report. This project was funded by the Coorong, Lower Lakes and Murray Mouth Recovery Project of the Department of Environment, Water and Natural Resources.

## Executive Summary

*Schoenoplectus validus* is a large, native, perennial, rhizomatous sedge that grows to 2–3 m high in water up to 1.5 m deep and is a common emergent species around the edges of lakes Alexandrina and Albert. Unlike other large emergent species present in the Lower Lakes, such as *Phragmites australis* and *Typha domingensis*, it does not form dense monospecific stands and usually grows in deeper water than the aforementioned species, often in association with aquatic taxa such as *Myriophyllum* spp., *Potamogeton* spp. and *Vallisneria australis*. *Schoenoplectus validus* is a robust species; often growing on shorelines subjected to wave action and providing sheltered areas where less robust species can persist. These characteristics have resulted in *Schoenoplectus validus* being planted extensively around the edges of lakes Alexandrina and Albert, primarily to reduce shoreline erosion.

Despite *Schoenoplectus validus* being extensively planted there has been little monitoring to evaluate the survivorship, density and extent of the plantings. Furthermore, there is no information regarding the benefits of planting *Schoenoplectus validus* on the aquatic plant community. This project was designed to address these data deficiencies and had two aims:

- Assess survivorship, density height and extent of *Schoenoplectus validus* plantings in lakes Alexandrina and Albert.
- Investigate the effect of *Schoenoplectus validus* planting on the aquatic plant community by comparing the plant community in planted and non-planted areas.

Survivorship, stand width, stem density and maximum and mean stem height of *Schoenoplectus validus* were assessed at seven shorelines (four old plantings; 6 to 7.5 years old and three new plantings; 0.5 to 1.5 years old) where the species had been planted. The benefits of planting to the aquatic plant community were assessed by comparing the plant community at planted and adjacent unplanted (control) shorelines.

*Schoenoplectus validus* had survived the period of low water levels in the Lower Lakes (2007 to 2010) and had recolonised (from rhizomes that persisted through the drought) all planted areas. Stem density and stand width was higher in the older plantings except at one site where recolonisation was limited and there was a weak linear relationship between stand age and stem density. Maximum and mean stem height were relatively consistent across all sites, which was due to mature ramets being planted.

At three out of the four shorelines with old plantings present there was a higher abundance and larger area of native submergent, amphibious and emergent species compared to the adjacent



control shoreline. In addition, submergent species were present at two of the three shorelines with new plantings and absent at the control shorelines. This indicated that planting *Schoenoplectus validus* benefits the aquatic plant community by providing a sheltered area where less robust species are able to colonise and persist even in newly planted areas.

These results showed that planting *Schoenoplectus validus* has greater benefits than just erosion control and can facilitate the establishment of species rich wetland plant communities on the shorelines of lakes Alexandrina and Albert in areas that would be otherwise devoid of vegetation or dominated by *Typha domingensis* or *Phragmites australis*. In addition data collected showed that diverse plantings are not required to establish species rich wetland communities and revegetation resources could be directed to planting a single species.

## 1. Introduction and context

*Schoenoplectus validus* is large, native, perennial, rhizomatous sedge that grows 2–3 m in height (up to 5 m in very favourable conditions) in water up to 1.5 m deep (Cunningham *et al.* 1992; Sainty and Jacobs 2003). Ecosystem services provided by *Schoenoplectus validus* include erosion control, waterbird habitat, fish habitat, sediment and water column aeration and water quality improvement (Sainty and Jacobs 2003). It is a common emergent species around the edges of Lakes Alexandrina and Albert, but unlike the other two large emergent species present in the Lower Lakes, *Phragmites australis* and *Typha domingensis*, it does not form dense monospecific stands (Gehrig *et al.* 2011; 2012). *Schoenoplectus validus* usually grows in deeper water than *Typha domingensis* and *Phragmites australis* and is often associated with submergent taxa such as *Myriophyllum* spp., *Potamogeton* spp. and *Vallisneria australis* (Gehrig *et al.* 2011; 2012). In addition, this species is robust and will grow in areas subjected to wave action providing sheltered areas where submergent and less robust emergent species can persist (Gehrig *et al.* 2012).

The ability of *Schoenoplectus validus* to tolerate wave action has resulted in it being planted extensively around the edges of lakes Alexandrina and Albert in water depths up to 1 m, primarily to control erosion (Goolwa to Wellington Local Action Planning Board *et al.* no date). However, there is evidence from The Living Murray (TLM) vegetation condition monitoring that the “breakwater” effect provided by this species also creates areas suitable for the establishment of less robust species (Gehrig *et al.* 2012).

Despite *Schoenoplectus validus* being planted extensively around the shorelines of lakes Alexandrina and Albert, there has been little monitoring to evaluate the survivorship, density and extent of the plantings. Furthermore, there is no information regarding the potential benefits (or negative impacts) of planting *Schoenoplectus validus* on the aquatic plant community. This project was designed to address these data deficiencies and had two aims:

- Assess survivorship, density height and extent of *Schoenoplectus validus* plantings in lakes Alexandrina and Albert.
- Investigate the effect of *Schoenoplectus validus* planting on the aquatic plant community by comparing the plant community in planted and non-planted areas.

## 2. Methods

### 2.1. Vegetation surveying protocol

A total of seven shorelines were surveyed at locations where *Schoenoplectus validus* had been planted; two in Lake Alexandrina (Wellington Lodge and Raukkan) and five in Lake Albert (Dumandang, Lake Albert Rd, Meningie Foreshore and two at Nurra Nurra Point) (Figure 1). Control sites were established adjacent to all sites except Lake Albert Road and Meningie foreshore (Figure 1). At Lake Albert Road the planting extended a considerable distance along the shoreline, resulting in the adjacent shoreline being too close to the Narrung Narrows at the western end of the planting and at the eastern end at the inlet of Waltowa Swamp. Both these areas were considerably different to the planted area; hence, a control site was established at the northern end of Brown Beach (Figure 1). The shoreline adjacent to the Meningie Foreshore site was also different to the planted shoreline. The shoreline to the south was highly modified (jetties and the boat ramp) and extensive erosion control works had been undertaken on the shoreline to the north; hence, a control site was established at the southern end of Brown Beach (Figure 1). GPS coordinates of sites and the year *Schoenoplectus validus* was planted at each site are presented in Appendix 1.

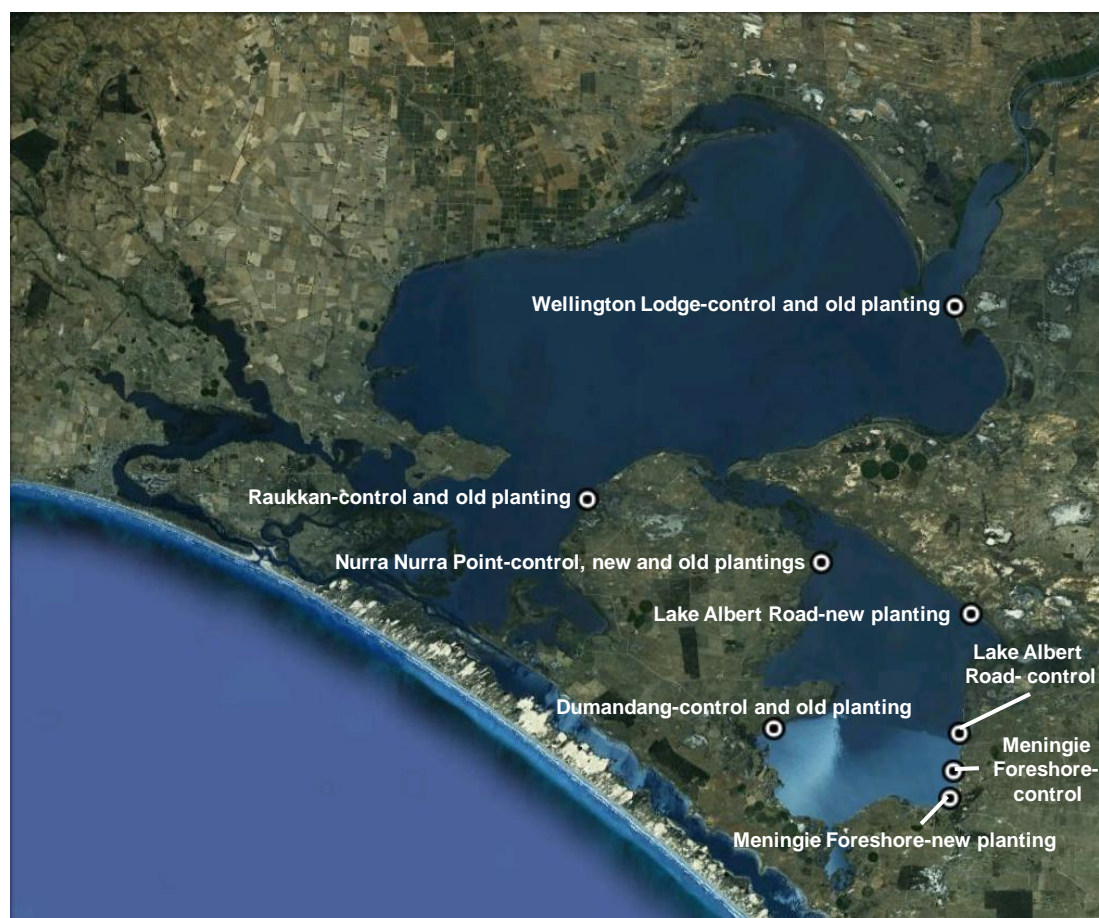
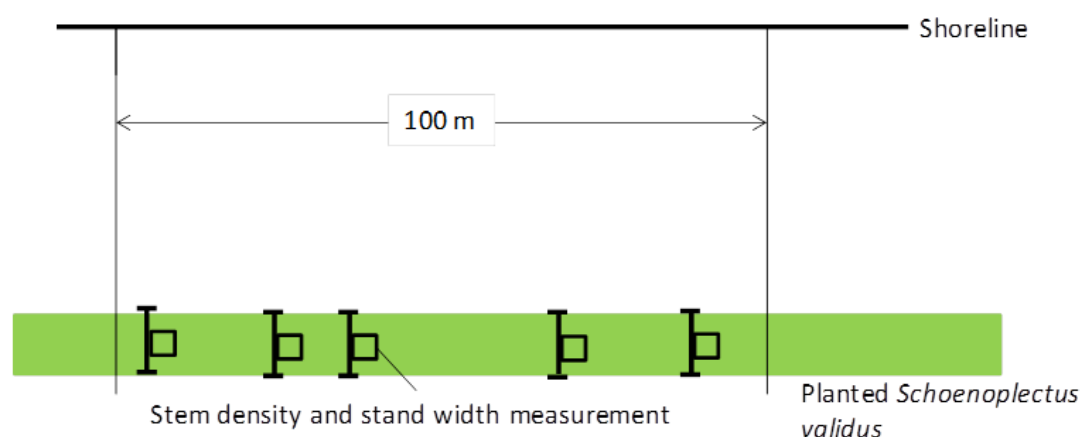

**Figure 1:** Aerial photograph of lakes Alexandrina and Albert showing the survey locations.

At each planting and control site, a 100 m section of shoreline was selected where the survivorship, density height and extent of planted of *Schoenoplectus validus* and benefit of planting to the aquatic plant community were assessed.

#### Survivorship, density, height and extent of *Schoenoplectus validus* plantings

The survivorship, density, height and extent of planted *Schoenoplectus validus* was assessed by measuring stem density, maximum stem height, mean stem height and stand width at five random sites along the 100 m section of shoreline (determined using a random number generator between 0 and 99 and undertaking measurements at the corresponding metre mark on a 100 m measuring tape) (Figure 2). Stem density was measured by recording the number of stems in a 1 x 1 m quadrat and stand width measured along the left hand edge (facing the shoreline) of the quadrat (Figure 2). The tallest stem in the quadrat and the height of ten random stems were measured from the lake bed. In addition, water depth was measured at each quadrat to determine emergent height, although this was not reported because planting depth was consistent across sites (<10 cm range between sites).



**Figure 2:** Plan view of a planted shoreline section showing the stand width measurement and quadrats within which stem density and height measurements were undertaken.

#### Benefit of *Schoenoplectus validus* plantings for the aquatic plant community

The vegetation monitoring protocol used the same methods as the TLM lake shore vegetation condition monitoring for lakes Alexandrina and Albert (Gehrig *et al.* 2012). This will enable quantitative comparison of data collected to be compared to data collected as part of the TLM vegetation condition monitoring, if required. Transects were established perpendicular to the shoreline at each end and in the middle of the 100 m shoreline section at planted and control locations (Figure 3).

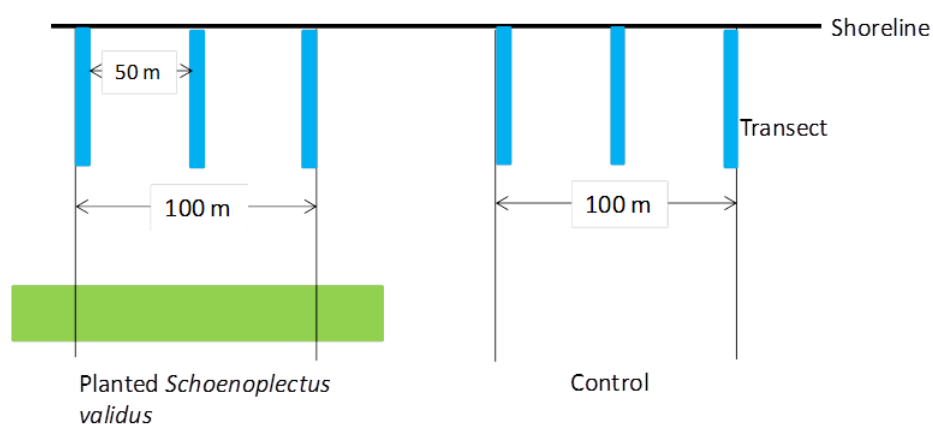

**Figure 3:** Plan view of planted and control shoreline sections showing the placement of vegetation monitoring transects.

Along each transect three 1 x 3 m quadrats separated by 1 m were established at +0.8, +0.6, +0.4, +0.2, and 0 AHD (Figure 4). Quadrats at lower elevations were not surveyed due to the absence of vegetation at all sites. Cover and abundance of each species present in the quadrat

were estimated using the method outlined in Heard and Channon (1997) except that N and T were replaced by 0.1 and 0.5 to enable statistical analyses (Table 1).

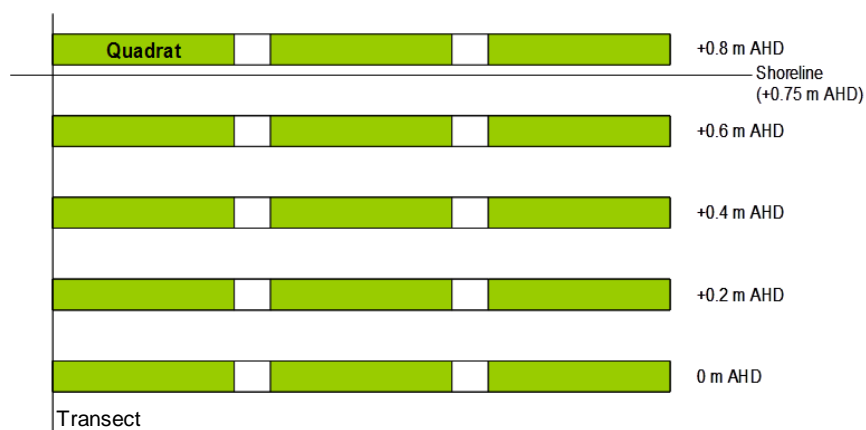

**Figure 4:** Vegetation surveying protocol for each transect: plan view showing placement of quadrats relative to the shoreline and transect.

**Table 1:** Modified Braun-Blanquet (1932) scale estimating cover/abundance as per Heard and Channon (1997).

Score	Modified Score	Description
N	0.1	Not many, 1-10 individuals
T	0.5	Sparsely or very sparsely present; cover very small (less than 5%)
1	1	Plentiful but of small cover (less than 5%)
2	2	Any number of individuals covering 5-25% of the area
3	3	Any number of individuals covering 25-50% of the area
4	4	Any number of individuals covering 50-75% of the area
5	5	Covering more than 75% of the area

## 2.2. Data analysis

Stand width and stem density and height data were presented graphically and the relationship between stand age (time since planting) and stem density and stand width analysed with regression analysis using Microsoft Excel. The difference in floristic composition between shorelines where *Schoenoplectus validus* has been planted and control shorelines was analysed individually for each site using multivariate PERMANOVA (Anderson 2001; Anderson and Ter Braak 2003) and non-metric scaling (NMS) ordination, (McCune *et al.* 2002) using the package PRIMER version 6.1.12 (Clarke and Gorley 2006). Bray-Curtis (1957) similarities were used to construct the similarity matrices for PERMANOVA and NMS ordination analyses and  $\alpha=0.05$  for all statistical analyses.

### 2.3. Plant identification and nomenclature

Plants present were identified to species where possible using keys in Sainty and Jacobs (1981), Jessop and Tolken (1986), Prescott (1988), Dashorst and Jessop (1998), Romanowski (1998), Sainty and Jacobs (2003) and Jessop *et al.* (2006). In some cases due to immature individuals or lack of floral structures, plants were identified to genus only. Nomenclature follows the Centre for Australian National Biodiversity Research and Council of Heads of Australasian Herbaria (2013).

## 3. Results

### 3.1. Survivorship, density, height and extent of *Schoenoplectus validus* plantings

#### Survivorship

Live *Schoenoplectus validus* was present at all planted sites indicating it survives transplanting well. Furthermore, at Raukkan, Dumandang, Wellington Lodge and Nurra Nurra Point (which were all planted prior to 2007), *Schoenoplectus validus* survived nearly three years of exposure as buried rhizomes.

## Stem density

Stem density was higher at the sites planted prior to 2007, except at Nurra Nurra Point where the stem density was similar to sites that were planted in the last two years (Figure 5). Linear regression analysis showed a weak positive relationship ( $R^2=0.4335$ ;  $P=0.007$ ) between stand age and stem density (Figure 6); however, if the data from Nurra Nurra Point are removed there is a positive, significant relationship ( $R^2=0.89$ ;  $P<0.001$ ).

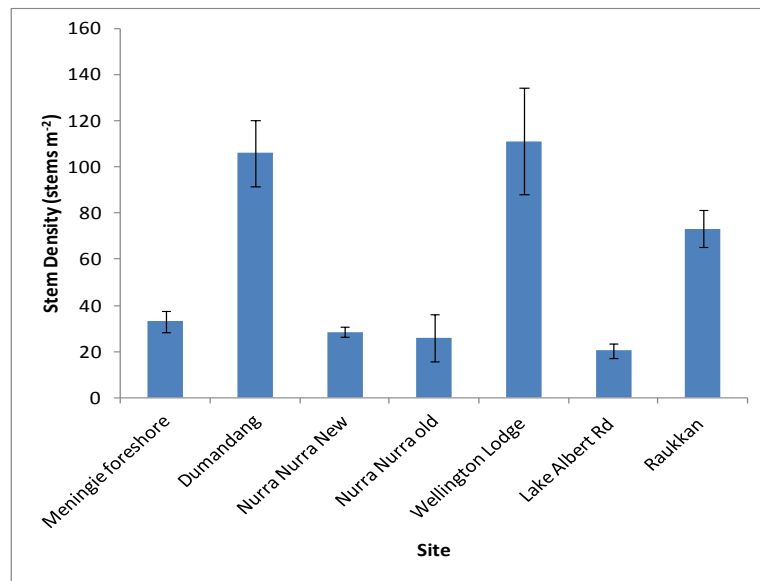

**Figure 5:** *Schoenoplectus validus* stem density (stems m<sup>-2</sup>) for each planted site in lakes Alexandrina and Albert, May 2013 (error bars=±1 SE).

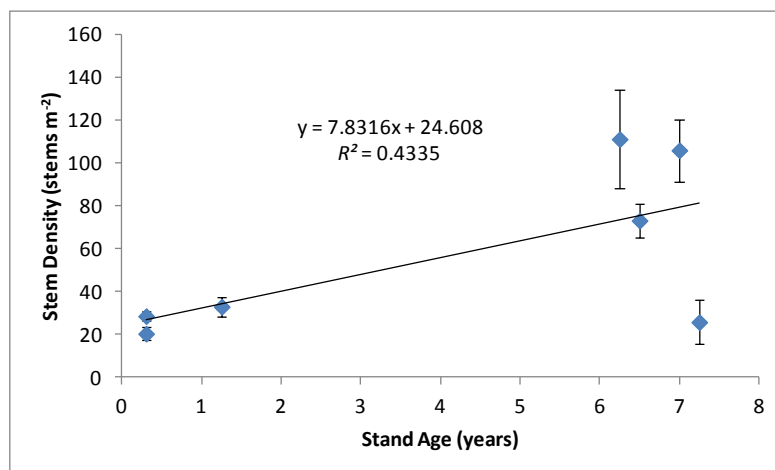
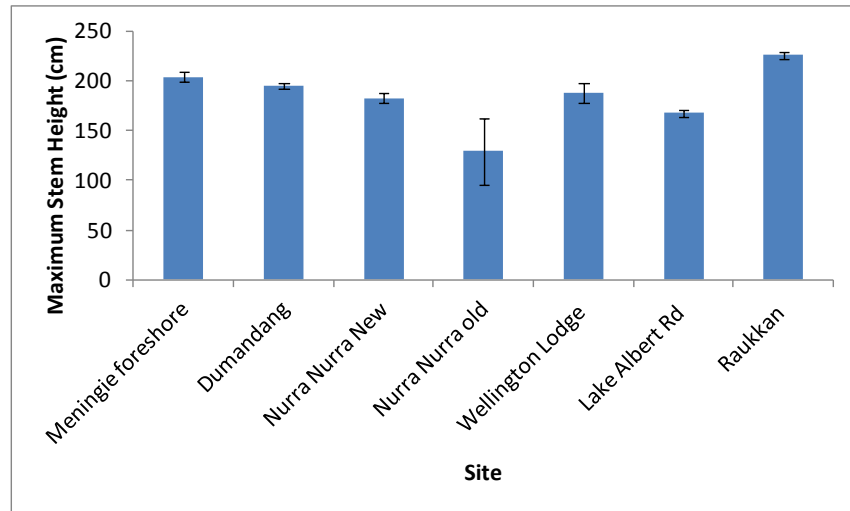

**Figure 6:** Relationship between *Schoenoplectus validus* stem density (stems m<sup>-2</sup>) and stand age, for each planted site in lakes Alexandrina and Albert, May 2013 (error bars=±1 SE).



### Maximum stem height

The height of the tallest stems was relatively consistent between sites with heights ranging from 178 to 221 cm, except at the old planting at Nurra Nurra Point where the maximum height of stems was lower and more variable (Figure 7). Due to the consistent maximum height of stems there was no relationship between stand age and maximum stem height (Figure 8).



**Figure 7:** *Schoenoplectus validus* maximum stem height for each planted site in lakes Alexandrina and Albert, May 2013 (error bars= $\pm 1$  SE).

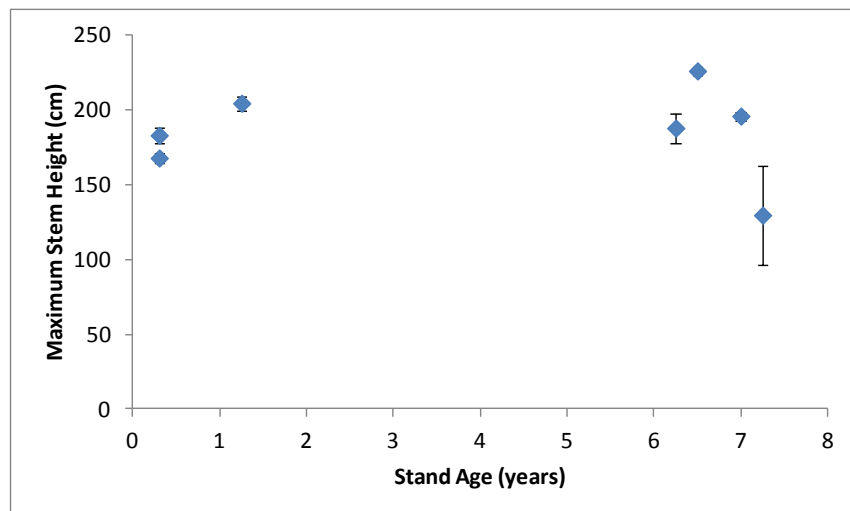

**Figure 8:** Relationship between *Schoenoplectus validus* maximum stem height and stand age, for each planted site in lakes Alexandrina and Albert, May 2013 (error bars= $\pm 1$  SE).

### Mean stem height

Mean stem height was highest at Raukkan, similar between Lake Albert Lodge, Meningie Foreshore, the new planting at Nurra Nurra Point and Dumandang and lowest at the old planting at Nurra Nurra Point and Lake Albert Rd (Figure 9). Similar to maximum stem height, there was no relationship between stand age and mean stem height (Figure 10).

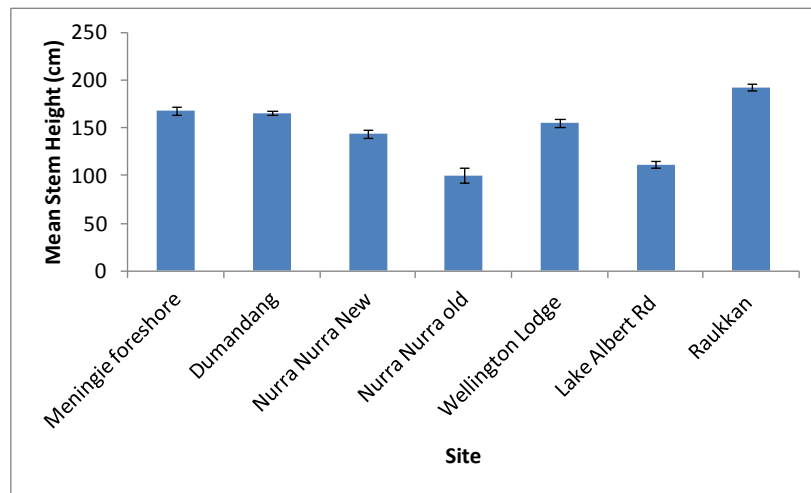

**Figure 9:** *Schoenoplectus validus* mean stem height for each planted site in lakes Alexandrina and Albert, May 2013 (error bars= $\pm 1$  SE).

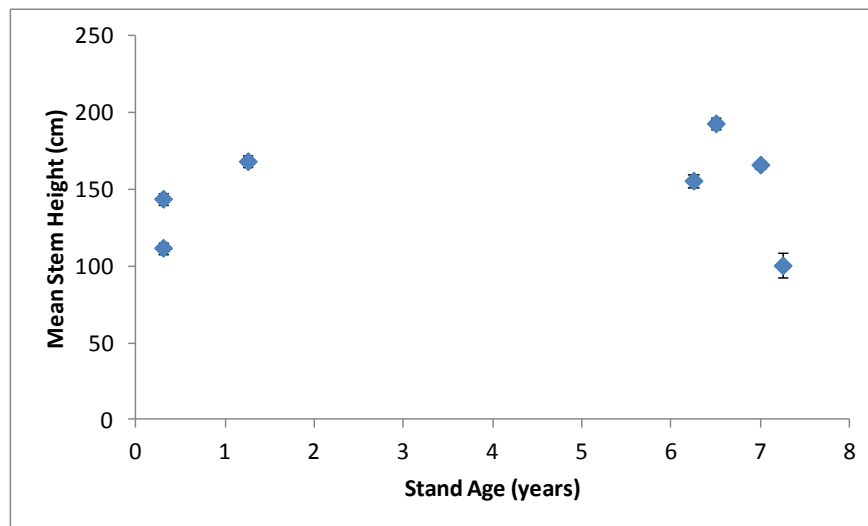

**Figure 10:** Relationship between *Schoenoplectus validus* mean stem height and stand age, for each planted site in lakes Alexandrina and Albert, May 2013 (error bars= $\pm 1$  SE).

## Stand width

The widest planted *Schoenoplectus validus* stands were at Raukkan and Wellington Lodge where stands were in excess of 6 m (up to over 10 m at Raukkan) wide in places (Figure 11). The newly planted sites (Meningie Foreshore, Lake Albert Road and Nurra Nurra new) were generally 2 m wide with little variability (Figure 11). Dumandang and the old planting at Nurra Nurra Point, despite being of similar age to Raukkan and Wellington Lodge, were only 3 to 5.5 m wide (Figure 11). There was a positive relationship between stand age width ( $R^2=0.4108$ ;  $P=0.009$ ) (Figure 12) due to the narrow stands at Dumandang and the old planting at Nurra Nurra Point (Figure 11).

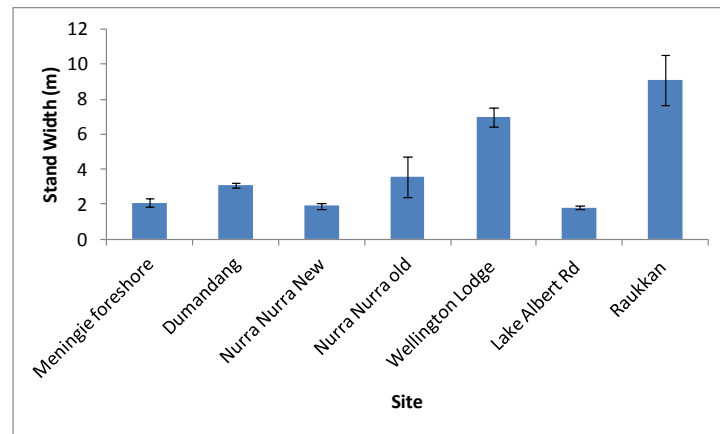

**Figure 11:** *Schoenoplectus validus* stand width for each planted site in lakes Alexandrina and Albert, May 2013 (error bars= $\pm 1$  SE).

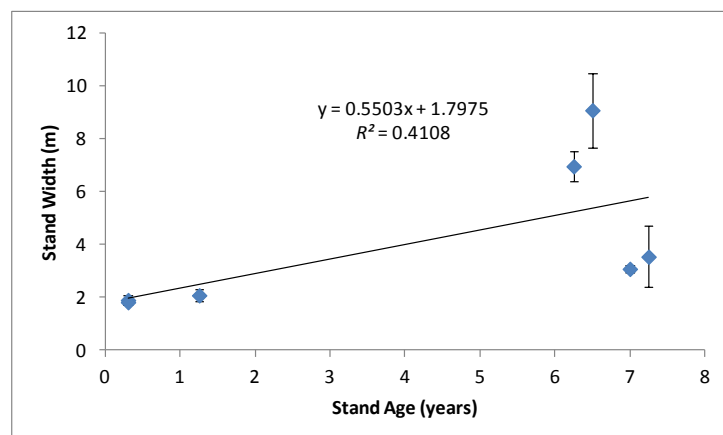

**Figure 12:** Relationship between *Schoenoplectus validus* stand width and stand age, for each planted site in lakes Alexandrina and Albert, May 2013 (error bars= $\pm 1$  SE).

### 3.2. Benefit of *Schoenoplectus validus* plantings for the aquatic plant community

#### Dumandang

PERMANOVA comparing the plant community at +0.8, +0.6, +0.4, +0.2 and 0 m AHD between the planted and control shorelines at Dumandang detected a significant interaction (Table 2). This indicated that the change in plant community along the elevation gradient was different between the control and planted shorelines. NMS ordination (Figure 13) showed that the plant community at 0 m AHD was very similar (generally devoid of plants) but there were differences at the other elevations. The upper elevations (+0.8 and +0.6 m AHD) at the control shoreline were dominated by exotic species (e.g. *Juncus acutus*, *Aster subulatus*, *Paspalum distichum*) but the planted shoreline was dominated by native emergent (e.g. *Phragmites australis*) and amphibious species (e.g. *Persicaria lapathifolia*, *Juncus kraussii*, *Duma florulenta*). The difference between the plant community at +0.4 and +0.2 m AHD was the higher cover of *Schoenoplectus validus* and presence of *Chara* sp. at the planted shoreline. The control shoreline at Dumandang was more species rich than the planted shoreline but that was due to the larger number of exotic species at the control shoreline (Appendix 2). The only submergent taxon present was *Chara* sp. and it was only recorded at the planted shoreline (Appendix 2).

**Table 2:** PERMANOVA results comparing the shoreline plant community between +0.8 and 0 m AHD between the planted and control shoreline at Dumandang.

Factor	DF	Pseudo F	P
Planting Status	1,89	7.72	<0.001
Elevation	4,89	14.69	<0.001
Planting Status x Elevation	4,89	2.22	0.013

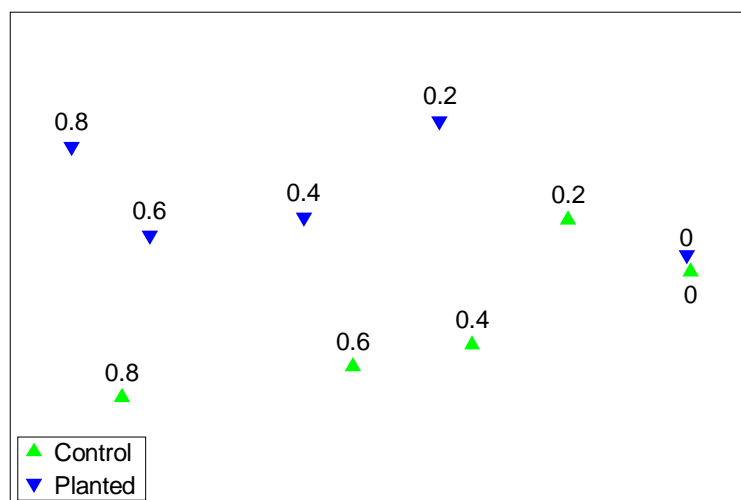

**Figure 13:** MDS ordination comparing plant community at +0.8, +0.6, +0.4, +0.2 and 0 m AHD between planted and control shoreline at Dumandang, May 2013. Stress = 0.02.

## Lake Albert Road

Similar to Dumandang, PERMANOVA detected a significant interaction comparing the plant community between the planted and control shoreline between +0.8 and 0 m AHD at Lake Albert Road (Table 3). NMS ordination showed that the plant community at the control shoreline was very similar regardless of elevation and also similar to the three lowest elevations (0, +0.2 and +0.4 m AHD) at the planted shoreline (Figure 14). The plant community at these locations was extremely depauperate or completely absent. In contrast, the plant community at the upper elevations at the planted shoreline was more species rich with emergent (*Phragmites australis*) and amphibious (*Juncus kraussii*, *Mimulus repens*, *Schoenoplectus pungens* and *Paspalum distichum*) species dominating the +0.8 m AHD elevation and amphibious (*Schoenoplectus pungens* and *Juncus kraussii*) and submergent species (*Myriophyllum salsgineum*, *Potamogeton pectinatus* and *Vallisneria australis*) present at +0.6 m AHD (Appendix 2). The planted shoreline (16 species) at Lake Albert Road was more species rich than the control shoreline (three species), which included three submergent taxa (Appendix 2).

**Table 3:** PERMANOVA results comparing the shoreline plant community between +0.8 and 0 m AHD between the planted and control shoreline at Lake Albert Road.

Factor	DF	Pseudo F	P
Planting Status	1,89	15.04	<0.001
Elevation	4,89	11.87	<0.001
Planting Status x Elevation	4,89	8.64	<0.001

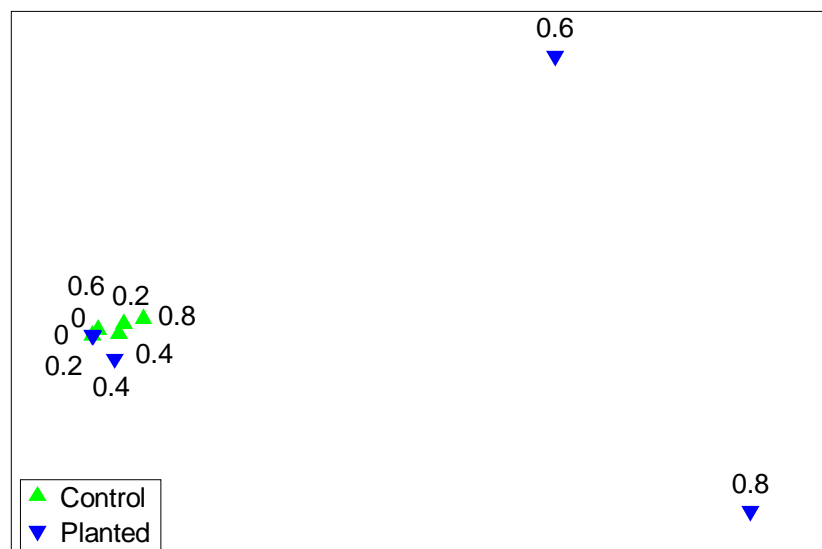

**Figure 14:** MDS ordination comparing plant community at +0.8, +0.6, +0.4, +0.2 and 0 m AHD between planted and control shoreline at Lake Albert Road, May 2013. Stress = 0.01.

## Meningie Foreshore

The significant interaction detected by PERMANOVA comparing the plant communities between 0 and +0.8 m AHD and the planted and control shorelines at Meningie Foreshore (Table 4) indicated the differences between the shorelines were not consistent across the elevation gradient. NMS ordination showed there was very little difference in the plant communities of the control and planted shorelines at 0 and +0.2 m AHD (Figure 15), which were both sparsely vegetated; however, there were differences between the two shorelines at the higher elevations (+0.4, +0.6 and +0.8 m AHD) (Figure 15). The control shoreline was sparsely vegetated with *Phragmites australis* and *Schoenoplectus pungens* present in low numbers; whereas, native emergent (*Bolboschoenus caldwellii* and *Typha domingensis*) and amphibious species (*Cyperus gymnocaulos*, *Eleocharis acuta*, *Calystegia sepium*, *Isolepis* sp. and *Mimulus repens*) were common at the planted shoreline (Appendix 2). Similar to Lake Albert Road, the planted shoreline was more species rich than the control shoreline with native emergent and amphibious taxa contributing to the higher species richness (Appendix 2).

**Table 4:** PERMANOVA results comparing the shoreline plant community between +0.8 and 0 m AHD between the planted and control shoreline at Meningie Foreshore.

Factor	DF	Pseudo F	P
Planting Status	1,89	11.33	<0.001
Elevation	4,89	12.31	<0.001
Planting Status x Elevation	4,89	3.82	<0.001

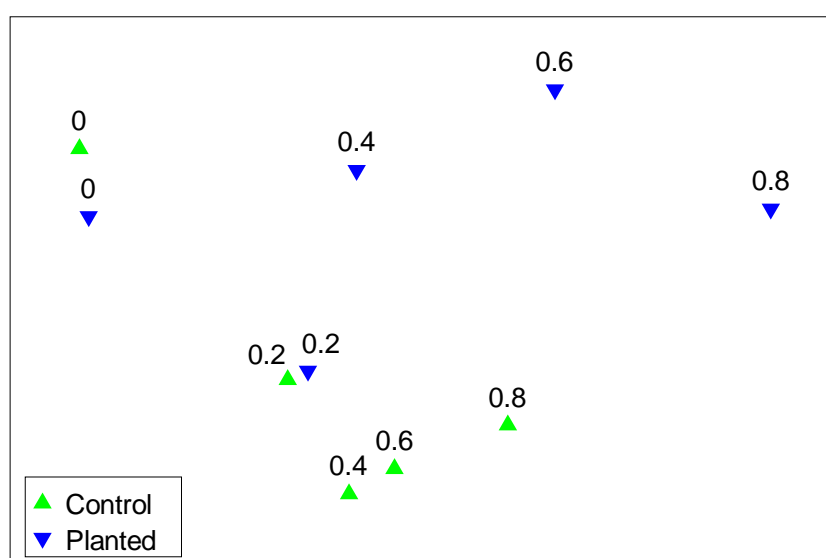

**Figure 15:** MDS ordination comparing plant community at +0.8, +0.6, +0.4, +0.2 and 0 m AHD between planted and control shoreline at Meningie Foreshore, May 2013. Stress =0.04.

## Nurra Nurra Point

PERMANOVA comparing the differences in the plant community from 0 to +0.8 m AHD between the control, new and old planted shorelines at Nurra Nurra Point showed that there was a difference between shorelines and elevations but no significant interaction (Table 5). NMS ordination showed that the plant community at 0 m AHD was the same at each shoreline; however, there were differences at the other elevation but the patterns were similar (Figure 16). *Schoenoplectus validus* was present at +0.2 m AHD at both planted shorelines, but absent from the control shoreline (Appendix 2). At all shorelines between +0.2 and +0.6 m AHD *Phragmites australis*, *Schoenoplectus pungens* and *Typha domingensis* were present and at +0.8 and +0.6 m AHD *Paspalum distichum* was present (Appendix 2). At the highest elevation, the terrestrial weeds *Pennisetum clandestinum*, *Oxalis pes-caprae*, *Sonchus oleraceus* and *Trifolium* spp. were present at all shorelines (Appendix 2). The differences between shorelines were due to different abundances of *Phragmites australis*, *Schoenoplectus pungens* and *Typha domingensis* at +0.2 to +0.6 m AHD and at +0.8 m AHD the presence (in low numbers) of different terrestrial taxa at the different shorelines (e.g. *Centaurea calcitrapa*, *Atriplex* spp., *Malva parviflora*) (Appendix 2). Species richness was similar across the different shorelines and *Myriophyllum salsugineum* was present at the control shoreline; however, only one individual was recorded (Appendix 2).

**Table 5:** PERMANOVA results comparing the shoreline plant community between +0.8 and 0 m AHD between the planted and control shoreline at Nurra Nurra Point.

Factor	DF	Pseudo F	P
Planting Status	2,134	9.40	<0.001
Elevation	4,134	14.97	<0.001
Planting Status x Elevation	8,134	1.20	0.216

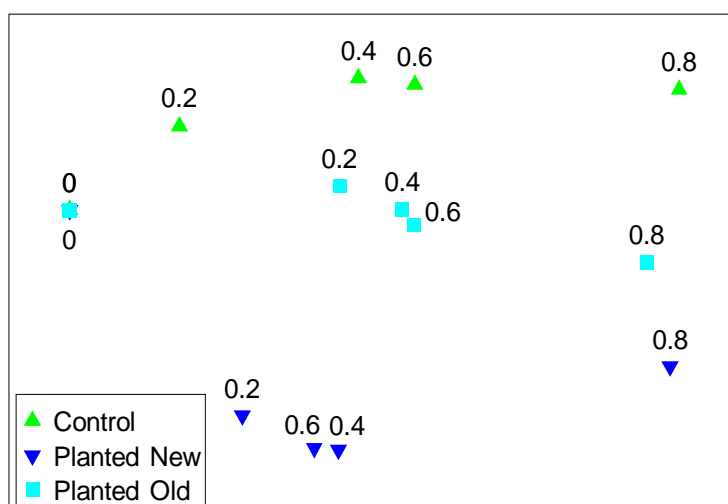

**Figure 16:** MDS ordination comparing plant community at +0.8, +0.6, +0.4, +0.2 and 0 m AHD between planted (new and old plantings) and control shoreline at Nurra Nurra Point, May 2013. Stress =0.09.

## Raukkan

The differences in the plant community between 0 and +0.8 m AHD were inconsistent between the control and planted shorelines at Raukkan; hence, the significant interaction detected by PERMANOVA (Table 6). NMS ordination showed that the plant community at the control shoreline between 0 and +0.6 m AHD was very similar (Figure 17) and generally devoid of vegetation. The +0.8 m elevation at the control shoreline was dominated by terrestrial species (primarily *Pennisetum clandestinum*) and low numbers of *Phragmites australis* (Appendix 2). The planted shoreline was different from the control shoreline at all elevations (Figure 17). The 0 and +0.2 m AHD elevations were dominated by *Schoenoplectus validus* and the vegetation cover at +0.4 and +0.6 m AHD was a species rich wetland community containing emergent (*Typha domingensis*, *Phragmites australis*, *Bolboschoenus caldwellii* and *Schoenoplectus validus*), amphibious (*Lemna* sp., *Azolla filiculoides*, *Centella asiatica*, *Schoenoplectus pungens* and *Rumex bidens*) and submergent (*Myriophyllum salsugineum* and *Ceratophyllum demersum*) taxa (Appendix 2). *Pennisetum clandestinum* was also abundant at +0.8 m AHD at the planted shoreline; however, native amphibious (*Ficinia nodosa*, *Schoenoplectus pungens*, *Cyperus gymnocaulos* and *Epilobium palladiflorum*) and emergent (*Phragmites australis*, *Bolboschoenus caldwellii* and *Typha domingensis*) species were also common (Appendix 2). The higher species richness at the planted shoreline was due to the wetland plant community present between the planted *Schoenoplectus validus* and shoreline (Appendix 2).

**Table 6:** PERMANOVA results comparing the shoreline plant community between +0.8 and 0 m AHD between the planted and control shoreline at Raukkan.

Factor	DF	Pseudo F	P
Planting Status	1,89	90.17	<0.001
Elevation	4,89	23.13	<0.001
Planting Status x Elevation	4,89	7.49	<0.001

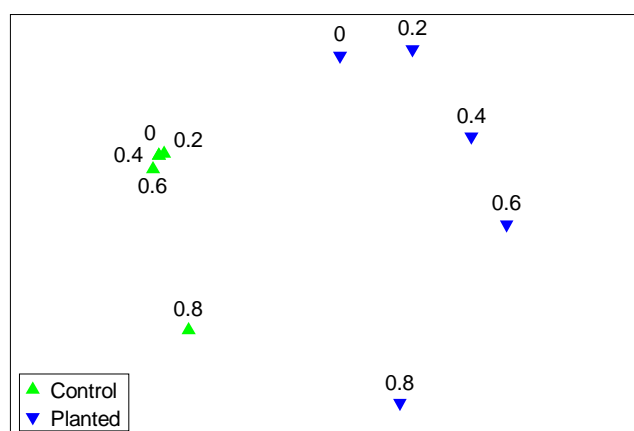

**Figure 17:** MDS ordination comparing plant community at +0.8, +0.6, +0.4, +0.2 and 0 m AHD between planted and control shoreline at Raukkan, May 2013. Stress =0.02.



## Wellington Lodge

Similar to Raukkan, PERMANOVA detected a significant interaction between planting status and elevation at Wellington Lodge (Table 7). The plant community at 0, +0.2 and +0.4 m AHD at the control shorelines and 0 m AHD elevation at the planted site were grouped together by NMS ordination (Figure 18) as all were devoid of vegetation. In contrast to Raukkan, native amphibious (*Azolla filiculoides*, *Cyperus gymnocaulos*, *Isolepis producta*, *Juncus holoschoenus*, *Juncus subsecundus*, *Limosella australis* and *Schoenoplectus pungens*), emergent (*Phragmites australis* and *Schoenoplectus validus*) and submergent (*Myriophyllum salsugineum*, *Vallisneria australis* and *Chara* sp.) taxa were present at the +0.6 and +0.8 m AHD elevations at the control shoreline (Appendix 2). The planted shoreline was less species rich compared to the control shoreline; however, there were a larger number of exotic taxa at the control shoreline (Appendix 2). Plants were present at greater depths at the planted shoreline compared to the control shoreline with *Schoenoplectus validus* present at +0.2 m AHD and emergent (*Typha domingensis*, *Schoenoplectus validus* and *Phragmites australis*), amphibious (*Persicaria lapathifolia*) and submergent (*Myriophyllum salsugineum* and *Vallisneria australis*) species abundant at +0.4 and +0.6 m AHD (Appendix 2). The highest elevation at the planted shoreline was dominated by native emergent (*Typha domingensis* and *Phragmites australis*) and amphibious (*Cyperus gymnocaulos*) species and the exotic terrestrial grass *Pennisetum clandestinum* (Appendix 2)

**Table 7:** PERMANOVA results comparing the shoreline plant community between +0.8 and 0 m AHD between the planted and control shoreline at Wellington Lodge.

Factor	DF	Pseudo F	P
Planting Status	1,89	16.23	<0.001
Elevation	4,89	11.83	<0.001
Planting Status x Elevation	4,89	5.75	<0.001

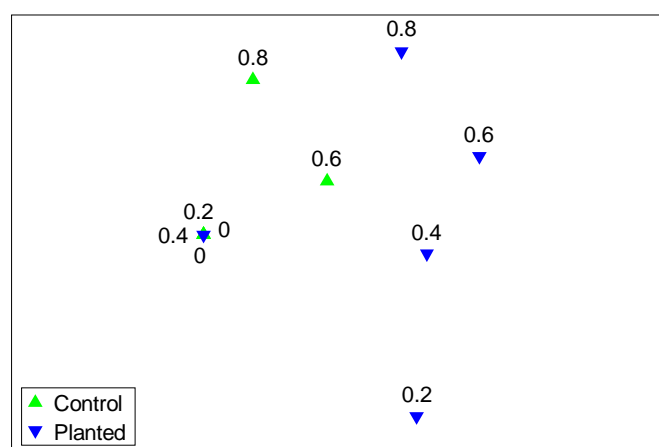

**Figure 18:** MDS ordination comparing plant community at +0.8, +0.6, +0.4, +0.2 and 0 m AHD between planted and control shoreline at Wellington Lodge, May 2013. Stress =0.06.

## 4. Discussion

Results from this study showed that *Schoenoplectus validus* is an appropriate species for planting in shallow water around the edges of lakes Alexandrina and Albert as it will grow in deeper water than other emergents (e.g. *Typha domingensis* and *Phragmites australis*) (Sainty and Jacobs 1981; Sainty and Jacobs 2003) and was able to persist as rhizomes through the period of low water levels from 2007 to 2010. Nicol (2010) and Nicol *et al.* (2013) observed survival of this species in wetlands between Mannum and Blanchetown over the same period; however, in those systems, rhizomes were covered by a thick layer of thatch comprising of senescent stems, which was absent in the Lower Lakes (J. Nicol pers. obs.).

The old plantings at Raukkan, Dumandang and Wellington Lodge displayed a high degree of resistance and within two and half years of water levels being reinstated in the Lower Lakes had recolonised large areas with stem densities often in excess of 100 stems m<sup>-2</sup> and stand widths of over 10 m in places. The old planting at Nurra Nurra Point did not show the same level of resistance as the other old plantings with stem densities and stand widths similar to the shorelines planted in recent years and it is unclear why this shoreline did not respond in a similar manner.

There were weak positive linear relationships between stand width and stem density and stand age (time since planting); however, a linear relationship may be inaccurate because there was a five year hiatus in planting and it is unknown whether maximum stand width or stem density thresholds had been reached. Therefore, an asymptotic relationship between time and stand width and stem density would be expected because stem density would eventually be limited by space and stand width by water depth. In contrast there was no relationship between maximum or mean height and stand age because mature ramets (clumps) were used for planting.

There is evidence that *Schoenoplectus validus* planted in 50 to 80 cm of water creates a 'breakwater' and provides a low energy environment where less robust plants can colonise. This was particularly evident at Raukkan where a diverse wetland plant community (including dense beds of the submergent species *Ceratophyllum demersum*, which were only present at this site) was present between the planted *Schoenoplectus validus* and the shoreline but less clear at Dumandang and Wellington Lodge where the control shorelines were more species rich and submergent taxa were present. Nevertheless, at Dumandang and Wellington Lodge the area occupied by submergent species was greater at the planted shoreline (J. Nicol and S. Gehrig pers. obs.) and extended into deeper water. Furthermore, several native emergent (e.g. *Bolboschoenus caldwellii*) and amphibious (*Mimulus repens*, *Calystegia sepium*, *Eleocharis acuta*, *Persicaria lapathifolia* and *Juncus*

*kraussii*) species were present at the planted shoreline but absent at the control (Appendix 2). Species rich wetland plant communities were not present at the old planted shoreline at Nurra Nurra Point, which was probably due to the low abundance of *Schoenoplectus validus* that did not yet provide protection from wave energy. Future monitoring is required to gain information regarding *Schoenoplectus validus* recolonisation and future benefits to the shoreline plant community.

There was evidence of the 'breakwater' effect at shorelines planted in the last two years. Species richness was higher and submergent species were present at the Lake Albert Road and Meningie Foreshore planted shorelines compared to the control shorelines where there were no submergent species and lower species richness. The minimum stem density or stand width required to reduce wave energy to a level that will allow the colonisation of wetland plant communities is unknown; however, at the aforementioned sites the planted clumps had not formed a continuous stand similar to those present at Dumandang, Raukkan or Wellington Lodge and the stand width was around 2 m.

Results from this project and The Living Murray vegetation condition monitoring showed that planting *Schoenoplectus validus* around the shorelines of the Lower Lakes can result in the development of diverse wetland plant communities in areas that are often bare shorelines or dominated by *Typha domingensis* or *Phragmites australis* (Gehrig *et al.* 2012). Similarly, areas where *Schoenoplectus validus* has colonised naturally (e.g. the Lake Alexandrina shoreline at Loveday Bay and the Bremer River Mouth and the lower Finniss River) tended to be more species rich with higher abundances of native submergent and amphibious species (Gehrig *et al.* 2011; Gehrig *et al.* 2012). This information is useful for managers because it provides evidence that planting one species can provide conditions that facilitate natural colonisation of wetland species and over time a species rich wetland plant community will develop. Furthermore, the 'breakwater' effect provided by *Schoenoplectus validus* can be used to control shoreline erosion, which is a problem in the Lower Lakes (PIRSA Spatial Information Services 2009). This information will inform revegetation works and provides evidence that planting multiple species is not required to establish diverse wetland plant communities around the shorelines of the Lower Lakes and resources can be directed to facilitate planting of *Schoenoplectus validus* in the future.

The capacity of planted *Schoenoplectus validus* to facilitate natural colonisation of wetland plant species has implications for biota associated with these habitats, especially fish. In Lake Alexandrina, three small-bodied threatened fish species, namely Yarra pygmy perch (*Nannoperca obscura*), southern pygmy perch (*Nannoperca australis*) and Murray hardyhead (*Craterocephalus fluvialilis*), are known to favour areas with diverse wetland plant cover, including *Schoenoplectus*

*validus* (Wedderburn *et al.* 2007; 2012; Hammer 2009). Thus, changes to vegetation communities as a result of planting of *Schoenoplectus validus* stand to benefit these species due to the provision of greater areas of favourable habitat. Hence, planting *Schoenoplectus validus* also shows potential as a habitat remediation tool within threatened fish conservation programs.

#### 4.1. Future research and monitoring

- Continue the monitoring program established in this study to gain further information regarding planted *Schoenoplectus validus* stand dynamics and the benefit to shoreline plant communities.
- Assess seed banks in planted and control areas and in areas where species rich wetland plant communities are present to determine if there is local capacity for a species rich wetland plant community to develop or whether sediment transplant is an option to accelerate the establishment of an aquatic plant community
- Expand the monitoring program to include other existing sites (e.g. Point Sturt) and new or potential sites.
- Compare planted shorelines with shorelines where *Schoenoplectus validus* has established naturally. This can be achieved by data sharing with The Living Murray condition monitoring.
- Investigate tolerances of common macrophytes in the Lower Lakes to wave action.

## 5. References

- Anderson, M.J. (2001). A new method for non-parametric analysis of variance. *Austral Ecology* **26**: 32-46.
- Anderson, M.J. and Ter Braak, C.J.F. (2003). Permutation tests for multi-factorial analysis of variance. *Journal of Statistical Computation and Simulation* **73**: 85-113.
- Braun-Blanquet, J. (1932). 'Plant Sociology.' (McGraw-Hill: New York).
- Bray, J.R. and Curtis, J.T. (1957). An ordination of the upland forest communities of southern Wisconsin. *Ecological Monographs* **27**: 325-349.
- Casanova, M.T. (2011). Using water plant functional groups to investigate environmental water requirements. *Freshwater Biology* **56**: 2637-2652.

Centre for Australian National Biodiversity Research and Council of Heads of Australasian Herbaria (2013). Australian Plant Census, IBIS database, <http://www.chah.gov.au/apc/index.html>.

Clarke, K.R. and Gorley, R.N. (2006). PRIMER version 6.1.12. (PRIMER-E Ltd: Plymouth).

Cunningham, G.M., Mulham, W.E., Milthorpe, P.L. and Leigh, J.H. (1992). 'Plants of Western New South Wales.' (CSIRO Publishing: Collingwood).

Dashorst, G.R.M. and Jessop, J.P. (1998). 'Plants of the Adelaide Plains and Hills.' (The Botanic Gardens of Adelaide and State Herbarium: Adelaide).

Gehrig, S.L., Nicol, J.M. and Bucater, L. (2011). Aquatic and littoral vegetation monitoring of Goolwa Channel 2009-11. South Australian Research and Development Institute (Aquatic Sciences), F2010/000383-2, Adelaide.

Gehrig, S.L., Nicol, J.M., Frahn, K.A. and Marsland, K.B. (2012). Lower Lakes vegetation condition monitoring – 2011/2012. South Australian Research and Development Institute (Aquatic Sciences), SARDI Publication No. F2010/000370-4, Adelaide.

Goolwa to Wellington Local Action Planning Board, Coorong District Local Action Plan Committee and Department for Environment and Heritage (no date). Revegetation guidelines for the Lower Lakes. Lake Alexandrina and Lake Albert region, South Australia. Goolwa to Wellington Local Action Planning Board, Coorong District Local Action Plan Committee and Department for Environment and Heritage, Adelaide.

Hammer, M. (2008). Status review of wild and captive populations of Yarra pygmy perch in the Murray-Darling Basin. Aquasave Consultants, Adelaide, 27pp.

Heard, L. and Channon, B. (1997). Guide to a native vegetation survey using the biological survey of South Australia. South Australian Department of Environment and Natural Resources, Adelaide.

Jessop, J., Dashorst, G.R.M. and James, F.R. (2006). 'Grasses of South Australia. An illustrated guide to the native and naturalised species.' (Wakefield Press: Adelaide).

Jessop, J.P. and Tolken, H.R. (1986). 'The Flora of South Australia.' (Government of South Australia Printer: Adelaide).

McCune, B., Grace, J.B. and Urban, D.L. (2002). 'Analysis of Ecological Communities.' (MjM Software Design: Gleneden Beach, Oregon).

Nicol, J.M. (2010). Vegetation monitoring of River Murray Wetlands downstream of Lock 1. South Australian Research and Development Institute (Aquatic Sciences), F2009/000416-1, Adelaide.

Nicol, J.M., Gehrig, S.L., Frahn, K.A. and Strawbridge, A.D. (2013). Resilience and resistance of aquatic plant communities downstream of Lock 1 in the Murray River. Goyder Institute for Water Research, Technical Report Series No. 13/5, Adelaide, South Australia.

PIRSA Spatial Information Services (2009). Erosion mapping of the shorelines of Lakes Alexandrina and Albert. Primary Industries and Resources South Australia (Spatial Information Services) and Goolwa to Wellington Local Action Planning Board Adelaide.

Prescott, A. (1988). 'It's Blue with Five Petals. Wild Flowers of the Adelaide Region.' (Ann Prescott: Prospect, South Australia).

Romanowski, N. (1998). 'Aquatic and Wetland Plants. A Field Guide for Non-tropical Australia.' (University of New South Wales Press: Sydney).

Sainty, G.R. and Jacobs, S.W.L. (1981). 'Water Plants of New South Wales.' (Water Resources Commission New South Wales: Sydney).

Sainty, G.R. and Jacobs, S.W.L. (2003). 'Waterplants in Australia.' (Sainty and Associates: Darlinghurst, N.S.W., Australia).

Wedderburn, S. D., K. F. Walker and B. P. Zampatti (2007). Habitat separation of *Craterocephalus* (Atherinidae) species and populations in off-channel areas of the lower River Murray, Australia. *Ecology of Freshwater Fish* **16**: 442-449.

Wedderburn, S. D., M. P. Hammer and C. M. Bice (2012). Shifts in small-bodied fish assemblages resulting from drought-induced water level recession in terminating lakes of the Murray-Darling Basin, Australia. *Hydrobiologia* **691**: 35-46.

## 6. Appendices

**Appendix 1:** GPS coordinates (UTM format; map datum WGS 84) of survey sites and when *Schoenoplectus validus* was planted at each site.

Site	Easting	Northing	Year Planted
Dumandang	339058	6053687	2003, 2004 and 2006
Dumandang Control	340594	6054244	NA
Lake Albert Road	350743	6060734	2013
Lake Albert Road Control	350313	6054328	NA
Meningie Foreshore	349673	6049720	2012
Meningie Foreshore Control	350237	6053018	NA
Nurra Nurra Point Control	341547	6063414	NA
Nurra Nurra Point Old	341723	6063637	2006
Nurra Nurra Point Young	341808	6063808	2012 and 2013
Raukkan	327643	6067143	2006
Raukkan Control	238006	6067827	NA
Wellington Lodge	349440	6079043	2007
Wellington Lodge Control	349469	6079117	NA

**Appendix 2:** Species list and functional group classification (*sensu* Casanova 2011) in planted and control areas in lakes Alexandrina and Albert (\*denotes exotic species, \*\*denotes proclaimed pest plant in South Australia, # denotes listed as rare in South Australia).

Species	Functional Group	Dumandang Control	Dumandang Planted	Lake Albert Rd Control	Lake Albert Rd Planted	Meningie Foreshore Control	Meningie Foreshore Planted	Nurra Nurra Control	Nurra Nurra New Planted	Nurra Nurra Old Planted	Raukkan Control	Raukkan Planted	Wellington Lodge Control	Wellington Lodge Planted
<i>Aster subulatus*</i>	Amphibious	P					P	P		P				
<i>Atriplex prostrata*</i>	Terrestrial												P	
<i>Atriplex</i> sp.	Terrestrial						P		P	P				
<i>Azolla filiculoides</i>	Amphibious											P	P	
<i>Bolboschoenus caldwellii</i>	Emergent						P			P		P		
<i>Brassica</i> sp.*	Terrestrial								P		P			
<i>Calystegia sepium</i>	Amphibious						P		P					
<i>Centaurea calcitrapa*</i>	Terrestrial	P						P	P					
<i>Centella asiatica</i>	Amphibious											P		
<i>Ceratophyllum demersum#</i>	Submergent											P		
<i>Chara</i> sp.	Submergent		P											
<i>Cladophora</i> sp.	Submergent												P	P
<i>Cotula coronopifolia*</i>	Amphibious	P					P	P	P					
<i>Cyperus gymnocaulos</i>	Amphibious						P					P	P	P
<i>Duma florulenta</i>	Amphibious		P											
<i>Eleocharis acuta</i>	Amphibious						P							
<i>Epilobium pallidiflorum</i>	Amphibious											P		
<i>Ficinia nodosa</i>	Amphibious											P		
<i>Fumaria bastardii*</i>	Terrestrial						P							
<i>Helichrysum luteoalbum</i>	Terrestrial							P						
<i>Hydrocotyle verticillata</i>	Amphibious	P												
<i>Hypochaeris glabra*</i>	Terrestrial				P									
<i>Hypochaeris radicata*</i>	Terrestrial											P		
<i>Isolepis producta</i>	Amphibious												P	
<i>Isolepis</i> sp.	Amphibious						P							
<i>Juncus acutus*</i>	Amphibious	P											P	
<i>Juncus holoschoenus</i>	Amphibious												P	
<i>Juncus kraussii</i>	Amphibious		P		P									
<i>Juncus subsecundus</i>	Amphibious												P	
<i>Lagurus ovatus*</i>	Terrestrial											P		
<i>Lemna</i> sp.	Amphibious											P		
<i>Limosella australis</i>	Amphibious												P	
<i>Lolium</i> spp.*	Terrestrial	P												
<i>Lythrum salicaria</i>	Amphibious	P												
<i>Malva parviflora*</i>	Terrestrial							P						
<i>Melilotus indicus*</i>	Terrestrial				P					P				
<i>Mimulus repens</i>	Amphibious				P		P							
<i>Myriophyllum salsugineum</i>	Submergent				P			P				P	P	P
<i>Nitella</i> sp.	Submergent												P	
<i>Oxalis pes-caprae**</i>	Terrestrial							P	P	P				
<i>Paspalum distichum*</i>	Amphibious	P	P	P	P	P	P	P	P	P		P	P	P
<i>Pennisetum clandestinum*</i>	Terrestrial		P		P			P	P	P	P	P	P	P
<i>Persicaria lapathifolia</i>	Amphibious													P
<i>Phragmites australis</i>	Emergent	P	P	P	P	P	P	P	P	P	P	P	P	P
<i>Plantago coronopus*</i>	Terrestrial	P			P		P						P	
<i>Polypogon monspeliensis*</i>	Amphibious	P					P		P					
<i>Potamogeton pectinatus</i>	Submergent				P									
<i>Ranunculus trilobus*</i>	Amphibious						P							
<i>Rumex bidens</i>	Amphibious								P			P		
<i>Scaevola</i> sp.	Terrestrial						P							
<i>Schoenoplectus pungens</i>	Amphibious	P	P	P	P		P	P	P	P	P	P	P	P
<i>Schoenoplectus validus</i>	Emergent	P	P			P	P		P	P		P	P	P
<i>Senecio pterophorus*</i>	Terrestrial											P		
<i>Silybum marianum**</i>	Terrestrial				P									
<i>Sonchus asper*</i>	Terrestrial	P							P					



Species	Functional Group	Dumandang Control	Dumandang Planted	Lake Albert Rd Control	Lake Albert Rd Planted	Meningie Foreshore Control	Meningie Foreshore Planted	Nurra Nurra Control	Nurra Nurra New Planted	Nurra Nurra Old Planted	Raukkan Control	Raukkan Planted	Wellington Lodge Control	Wellington Lodge Planted
<i>Sonchus oleraceus</i> *	Terrestrial	P			P		P	P	P	P	P	P	P	
<i>Tecticornia pergranulata</i>	Amphibious	P												
<i>Trifolium</i> sp.*	Terrestrial	P			P		P	P	P	P		P		
<i>Typha domingensis</i>	Emergent	P					P	P	P	P		P		P
<i>Vallisneria australis</i>	Submergent				P								P	P
<b>Total</b>		<b>18</b>	<b>8</b>	<b>3</b>	<b>15</b>	<b>3</b>	<b>21</b>	<b>14</b>	<b>17</b>	<b>13</b>	<b>5</b>	<b>21</b>	<b>19</b>	<b>10</b>